

HENRY TECHNOLOGIES - CHECK VALVES (Globe Design)

FORGED BRASS BODY — TYPE 116

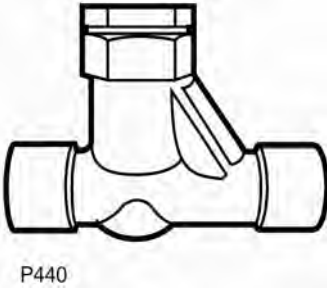

- Temperature rating -40° F to +300° F
- Maximum working pressure 500 psi

Teflon® synthetic seat, with fully guided piston and stainless steel spring. Will operate in any position except bonnet down. Internal parts can be easily removed to prevent damage when soldering valve into line. Suitable for highside or lowside installation and hot gas applications, refrigerants and other industrial fluids, non-corrosive to brass and steel.

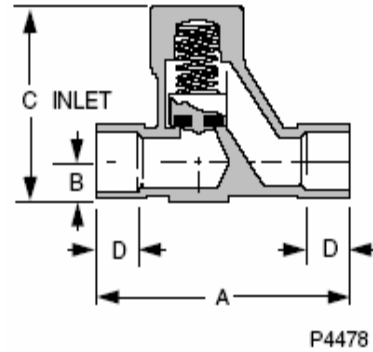

PART NO	SIZE CONN	DIMENSIONS (in)				WT(lb)
		A	B	C	D	
116003	3/8 ODS	2.94	.41	2.06	.31	.53
116004	1/2 ODS	2.94	.14	2.06	.38	.51
116005	5/8 ODS	2.94	.14	2.06	.50	.48
116007	7/8 ODS	3.88	.63	2.94	.88	2.04

FORGED BRASS BODY — TYPE 205

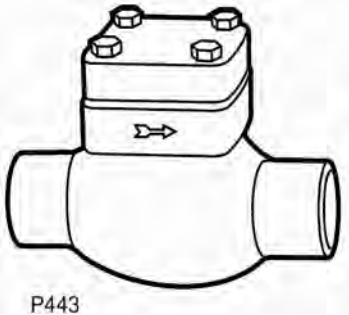

- Maximum working pressure 500 psi
- Temperature rating -20°F to +300°F

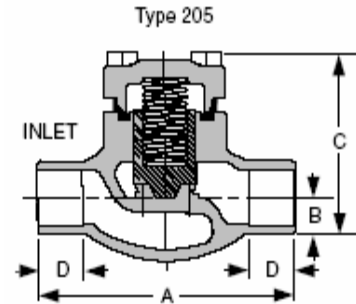

PART NO	SIZE CONN	DIMENSIONS (in)				WT(lb)
		A	B	C	D	
205-7/8	7/8	4.25	.97	3.16	.75	2.73
205-1-1/8	1-1/8	4.88	1.14	3.88	.94	4.41
205-1-3/8	1-3/8	5.38	1.25	4.25	1.00	6.04
205-1-5/8	1-5/8	6.50	1.50	5.06	1.13	9.32
205-2-1/8	2-1/8	8.50	2.00	5.88	1.50	17.10
205-2-5/8	2-5/8	11.00	2.25	6.88	1.69	27.43

HENRY TECHNOLOGIES - CHECK VALVES (Straight Through Design)

BRASS BODY — TYPE 119

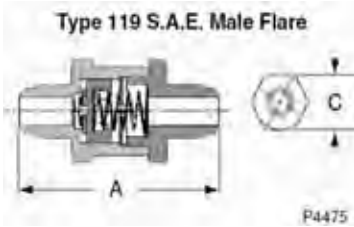

- Brass Construction with Synthetic Rubber Seat
- Complete Piston Guidance
- Stainless Steel Spring
- Operates in Any Position
- Temperature Rating -20°F to $+200^{\circ}\text{F}$
- Maximum Working Pressure 500 PSI

Compact, sturdy and noiseless in operation, with minimum pressure drop.

PART NO	SIZE CONN	DIMENSIONS (in)			WT(lb)
		A	B	C	
119-1/4	1/4 FL	2.26	—	.81	.22
119-3/8	3/8 FL	2.51	—	.81	.26

BRASS BODY — TYPE 120

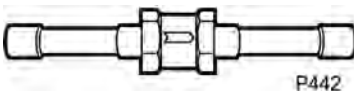

- Brass construction with synthetic rubber seat
- Complete Piston Guidance
- Stainless Steel Spring
- Operates in any position
- Temperature Rating -20°F to 200°F
- Maximum Working Pressure 500 PSI

Compact, sturdy and noiseless in operation, with minimum pressure drop.

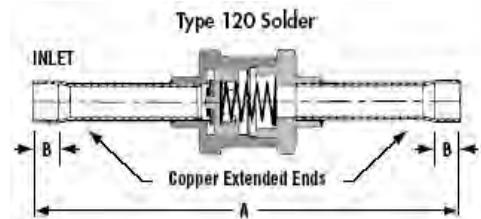

PART NO	SIZE CONN	DIMENSIONS (in)			WT(lb)
		A	B	C	
120-3/8	3/8 ODS	5.25	.31	.81	.28
120-1/2	1/2 ODS	6.34	.38	1.25	.57
120-5/8	5/8 ODS	6.28	.50	1.25	.64
120-7/8	7/8 ODS	6.44	.75	1.50	1.06

HENRY TECHNOLOGIES - ANGLE CHECK VALVES

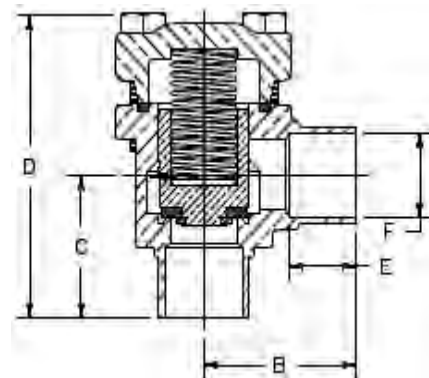
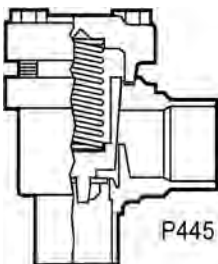

PART NO	SIZE CONN	DIMENSIONS (in)		
		Center to Bottom	Center to Side	Center to Height
215-7/8	7/8 ODS	1-1/2	1-3/4	3-3/16
215-1-1/8	1-1/8 ODS	1-3/4	2-3/16	3-7/16
215-1-3/8	1-3/8 ODS	1-15/16	2-7/16	4-3/8
215-1-5/8	1-5/8 ODS	2-5/32	2-3/4	5-1/16