

Refrigeration

MUELLER - CHECK VALVES TECHNICAL DATA

- Available in 1/4" thru 5/8" flare sizes and 1/4" thru 7/8" solder sizes.
- Recognized under the component program of Underwriters Laboratories for use in the USA and Canada.
- Maximum working pressure: 500 PSIG.
- Maximum temperature rating at +200° F.

Flare to Flare

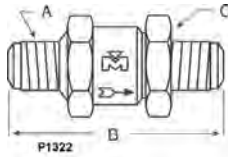

PART NO	SIZE Flare A	B	C	WT/ EA
A 15620	1/4	2-3/16	13/16 Hex	.14
A 15621	3/8	2-13/32	13/16 Hex	.18
A 15622	1/2	3	1-1/4 Oct	.44
A 15623	5/8	3-5/16	1-1/4 Oct	.52

SOLDER TO SOLDER

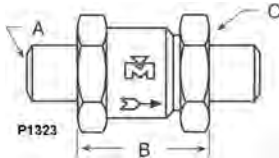

PART NO	SIZE OD A	B	C	WT/ EA
A 15628	1/4	1-3/16	13/16 Hex	.13
A 15629	3/8	1-5/32	13/16 Hex	.13
A 15630	1/2	1-7/16	1-1/4 Oct	.36
A 15631	5/8	1-7/16	1-1/4 Oct	.37

SOLDER TO SOLDER EXTENDED ENDS

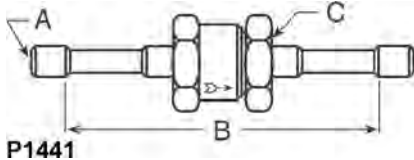

PART NO	SIZE OD A	B	C	WT/ EA
A 15632	1/4	4-7/16	13/16 Hex	.17
A 15633	3/8	4-9/16	13/16 Hex	.17
A 15634	1/2	4-29/32	1-1/4 Oct	.42
A 15635	5/8	5-13/64	1-1/4 Oct	.48

MUELLER - FOUR-BOLT CHECK VALVES

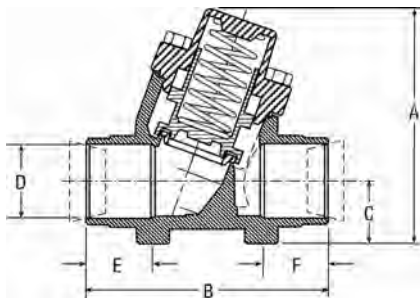
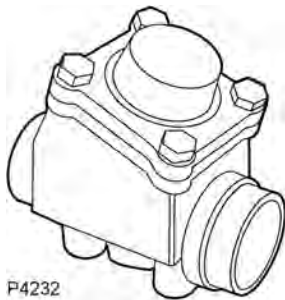

Specifications

Refrigerants	All fluorinated types	
Maximum Working Pressure	500 psig	
Burst Pressure	2500 psig	
Working Temperature Range	-40° F/300° F	
Pressure Required to Open	B 34235	<1 psi
	B 34236	<1 psi
	B 34237	2 psi
	B 34238	2 psi
	B 34239	2 psi
	B 34240	2 psi
Recommended Bolt Torques	B 34241	2 psi
	B 34235	8-15 ft-lb
	B 34236	8-15 ft-lb
	B 34237	10-20 ft-lb
	B 34238	10-20 ft-lb
	B 34239	10-20 ft-lb
B 34240	15-25 ft-lb	
B 34241	15-25 ft-lb	

NOTE: Not to be installed with the bonnet facing down.

PART NO	SIZE	A	B	C	D	E	Cv	Weight
B 34235	7/8	3-19/32	3-11/16	31/32	7/8	15/16	5.05	2.46
B 34236	1-1/8	3-19/32	3-11/16	31/32	1-1/8	1	6.70	2.31
B 34237	1-3/8	4-9/16	4-3/4	1-5/16	1-3/8	1-1/16	8.71	5.42
B 34238	1-5/8	4-9/16	4-3/4	1-5/16	1-5/8	1-1/16	10.06	5.04
B 34239	2-1/8	5-7/8	6-3/8	1-11/16	2-1/8	1-1/2	36	12.6
B 34240	2-5/8	8	8-7/8	2	2-5/8	1-7/8	70	*
B 34241	3-1/8	8	8-7/8	2	3-1/8	1-7/8	*	*

*Consult Factory.

Refrigeration

Compressors, Chillers, Condensers
 Motors
 Electrical
 Heating Components
 Indoor Air Quality
 Thermostats
 Oils & Chemicals
 Accessories, Supplies & Commodities
 Tools & Instruments
 Refrigeration

MUELLER - CYCLEMASTER BALL VALVES

Specifications

PART NO	SIZE	A (in)	B (in)	C (in)	D (in)	E (in)	F** (in)	G**(mm)	H**	SEAL CAP KIT****	Cv	Weight
A 17859*	1/4	5-7/16	2-15/16	5/16	7/8	2-3/4	NA	14	M4 x .07	A 17842	1.02	.70
A 17860*	3/8	5-1/2	3	5/16	7/8	2-3/4	15/16	14	M4 x .07	A 17842	4.29	.63
A 17861*	1/2	6-3/8	3-7/16	3/8	7/8	2-3/4	1-3/16	14	M4 x .07	A 17842	6.20	.62
A 17862*	5/8	6-3/8	3-7/16	1/2	7/8	2-3/4	1-3/8	14	M4 x .07	A 17842	11.20	.64
A 17863	3/4	7-7/16	3-7/8	5/8	1-1/4	3-1/2	1-1/2	20	M4 x .07	A 17843	18.95	1.15
A 17864	7/8	7-7/16	3-7/8	3/4	1-1/4	3-1/2	1-5/8	20	M4 x .07	A 17843	29.30	1.53
A 17865	1-1/8	8-7/16	4-5/16	7/8	1-9/16	3-13/16	1-3/4	25	M4 x .07	A 17844	59.55	2.92
A 17866	1-3/8	10	5	1	1-1/2	4-3/16	2-1/16	30	M6 x 1.0	A 17844	84.58	3.48
A 17867	1-5/8	11	5-1/2	1-1/8	1-11/16	4-7/8	2-1/4	34	M6 x 1.0	A 17845	225.04	5.02
A 17868	2-1/8	12	6	1-3/8	2-1/8	5-9/16	2-7/16	34	M6 x 1.0	A 17845	291.59	8.60
A 17869	2-5/8	13-1/2	6-13/16	1-1/2	***	***	***	34	M6 x 1.0	A 17846	423.47	14.00
A 17870	3-1/8	16	8	1-3/8	3	7-3/8	3-1/8	34	M6 x 1.0	A 17846	***	23.50
A 17871*	2-5/8	12	6	1-3/8	2-1/8	5-5/8	2-3/8	34	M6 x 1.0	A 17845	184.85	9.20
A 17872*	3-1/8	12	6	1-11/16	2-1/8	5-5/8	3-1/16	34	M6 x 1.0	A 17845	127.99	11.00

Technical Data

Refrigerants	HFC, CFC, HCFC
Maximum Working Pressure	700 psig
Working Temperature Range	-40° F/300° F

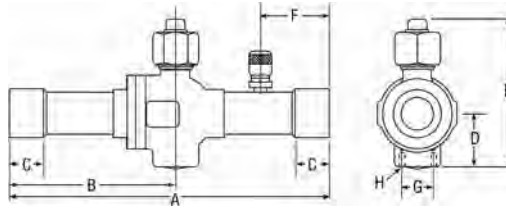

CYCLEMASTER Mueller 3-Way Ball Valves with Access Ports

Prefixed for Ball Valve Options:

- A = Standard
- AC = Standard with access
- AP = Drilled & tapped
- APM = Drilled & tapped with 1 piece seal cap
- AQ = Drilled & tapped with access
- AQM = Drilled & tapped with access & 1 piece seal cap
- AU = 3-way with access

Examples:

- A 17865: 1-1/8" without access
- AC17865: 1-1/8" with access
- AP17865: 1-1/8" drilled & tapped
- APM17865: 1-1/8" drilled & tapped with 1 piece seal cap
- AQ17865: 1-1/8" drilled & tapped with access
- AQM17865: 1-1/8" drilled & tapped with access & 1 piece seal cap
- AU17865: 1-1/8" 3-way with access

* Reduced port

**Where Applicable

***Consult factory for details

****Seal Cap Kit includes Seal Cap, Seal Cap Gasket, Anti-Friction Ring, Cap Nut.

. Sizes not available in "Standard, A" or "Standard with Access, AC" options substitute

"AP" for "A" and "AQ" for "AC".

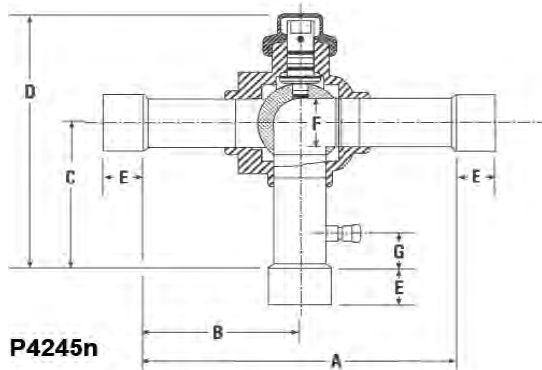

PART NO	SIZE	A (in)	B (in)	C (in)	D (in)	E (in)	F** (in)	G**(mm)	Cv	Weight
AU17860	3/8	4-7/8	2-21/32	2-19/64	3-21/32	5/16	1/2	41/64	2.23	.67
AU17861	1/2	5-3/8	3-3/64	2-43/64	4-7/32	3/8	1/2	53/64	3.94	.70
AU17862	5/8	5-3/8	2-59/64	2-35/64	4-7/64	1/2	1/2	27/32	4.63	.70
AU17863	3/4	6-1/4	3-57/64	3	5-1/4	5/8	3/4	55/64	11.90	NA
AU17864	7/8	5-31/32	3-5/32	2-29/32	4-7/8	3/4	3/4	27/32	10.89	1.44
AU17865	1-1/8	6-39/64	3-3/16	3-7/64	5-31/64	29/32	1	53/64	19.33	2.76
A 17545	1-3/8	8-1/16	4-7/64	3-61/64	6-57/64	31/32	1-1/4	1-5/64	31.06	4.97
A 17546	1-5/8	8-7/8	4-7/16	4-23/64	7-33/64	1-3/32	1-1/2	1-5/32	44.69	7.17
AU17868	2-1/8	9-5/16	4-39/64	4-23/32	8-13/32	1-11/32	2	1-5/64	76.32	13.80
AU17871	2-5/8	9-1/16	4-15/32	4-19/32	8-9/32	1-15/32	2	1-1/64	69.85	14.66
AU17872	3-1/8	8-11/16	4-9/32	4-11/32	8-3/32	1-21/32	2	1-27/64	58.19	15.48